

Nabídka nářadí a strojů firmy BENNETT Int.



Formas de bobinar
Coil forms



Insertador alternadores
Inserting tool alternator



Conformador
Preforming tool

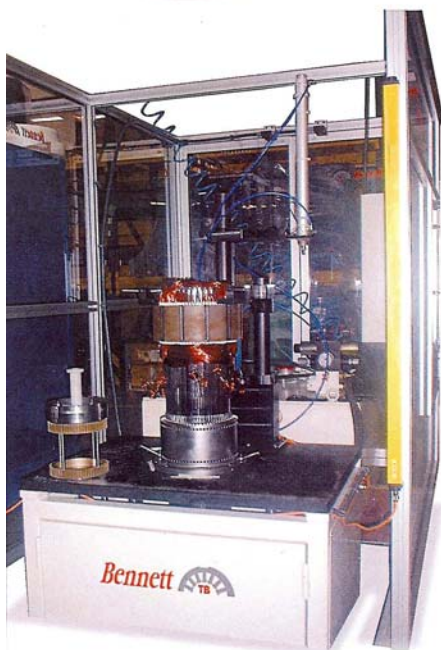

Insertadora semi-automática ISV-200
Semiautomatic inserting machine ISV-200

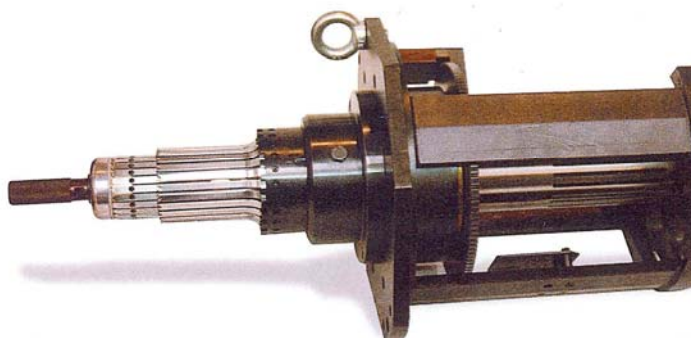

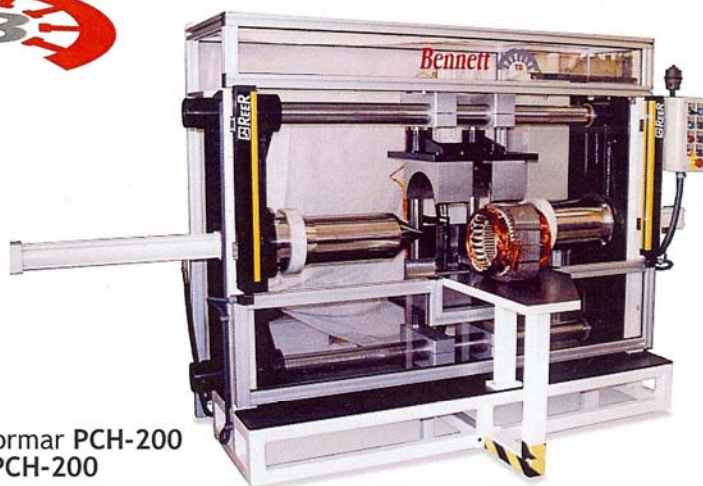

Prensa de conformar PCH-200
Forming press PCH-200

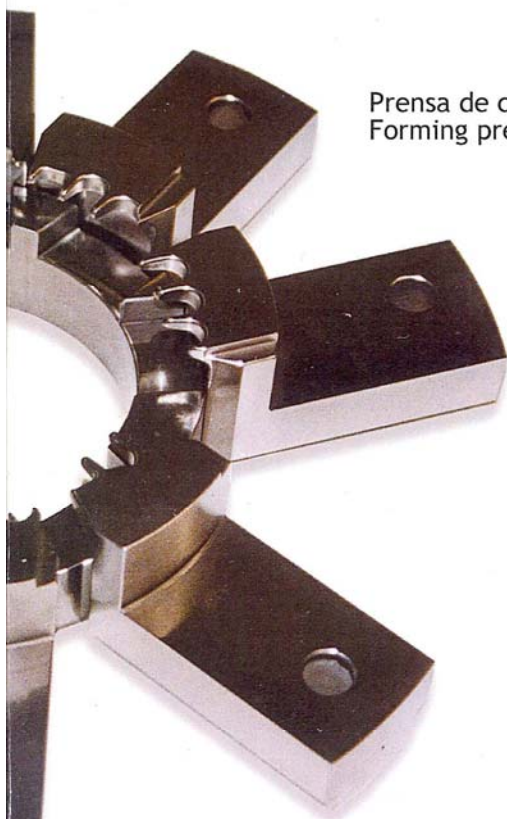

Prensa de conformar PCF-250
Forming press PCF-250



Prensa de conformar PCF-200
Forming press PCF-200

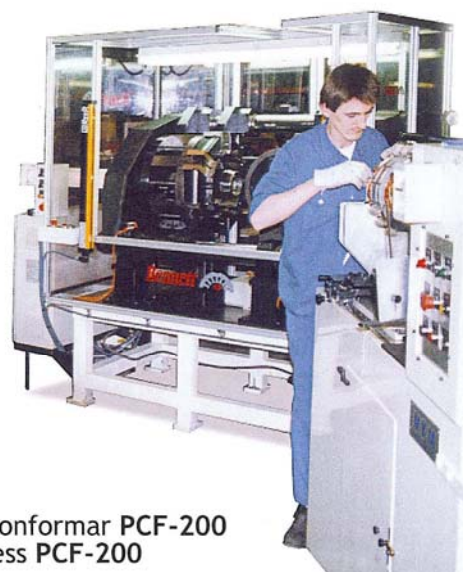



Formas de bobinar
Coil forms



Conformador
Preforming tool

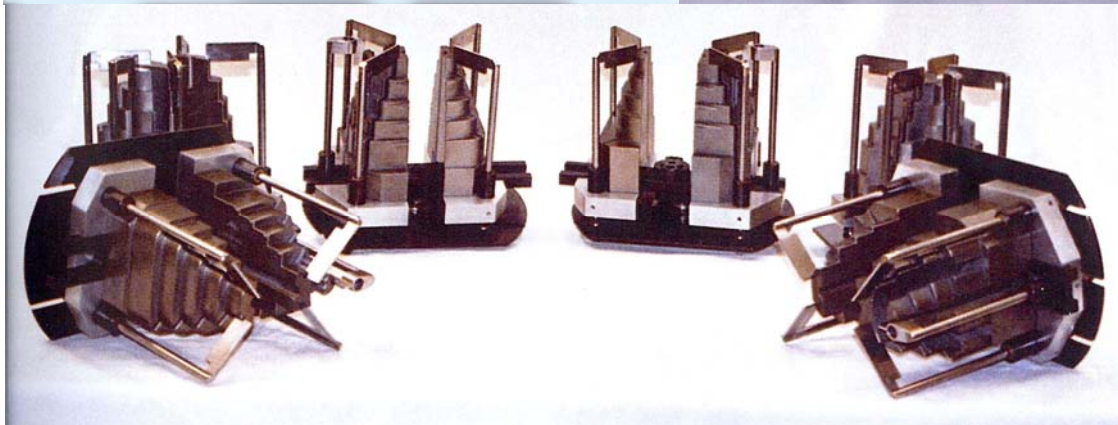

UTILES DE INSERTAR
INSERTING TOOLS

MP TRADE, V Pláni 534/14, 142 00 Praha 4, Česká republika

Útiles de bobinar

Somos especialistas en la elaboración de útiles para todo tipo de máquinas de bobinar

Winding Tools

A complete assortment of Winding Tools to provide solutions for every personal need

Outillages pour bobiner

Notre gamme de rechanges d'outillage pour bobiner vous offre une solution pour chaque problème

Utensili per bobinare

Il nostro servizio specializzato di ricambi per ogni tipo di utensili per bobinare è la soluzione dei Vostri problemi

Wickelwerkzeuge

Das ist die Lösung Ihrer Probleme. Bennett bietet Ihnen einen vollständigen Ersatzteildienst für sämtliche Spulenwickelmaschinen



Servicio de recambios

Bennett les ofrece un completo servicio de recambios para todo tipo de utillajes

Servizio di ricambi

La Bennett offre un completo servizio di ricambi per ogni tipo di utensile

Spare Parts Service

Bennett supplies a wide range of spare parts for any kind of tooling equipment

Service de rechanges

Bennett vous offre un service complet de rechanges pour n'importe que type d'outillages

Ersatzteildienst

Bennett bietet Ihnen einen vollständigen Ersatzteildienst für jede Art von Werkzeugausrüstungen





UTIL DE INSERTAR " STATOMAT - SE "
INSERTING TOOL " STATOMAT - SE "



1030



Bennett *TBS*
BARCELONA - SPAIN



MOLDES DE BOBINAR " STATOMAT "
WINDING TOOL " STATOMAT "



1011



Bennett *TBS*
BARCELONA - SPAIN

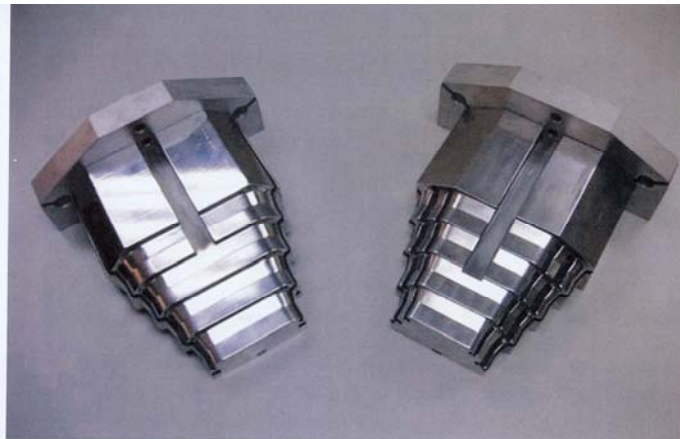

WINDING FORMS FOR STATOMAT MACHINE FW1/600



1051



Bennett *TBS*
BARCELONA - SPAIN

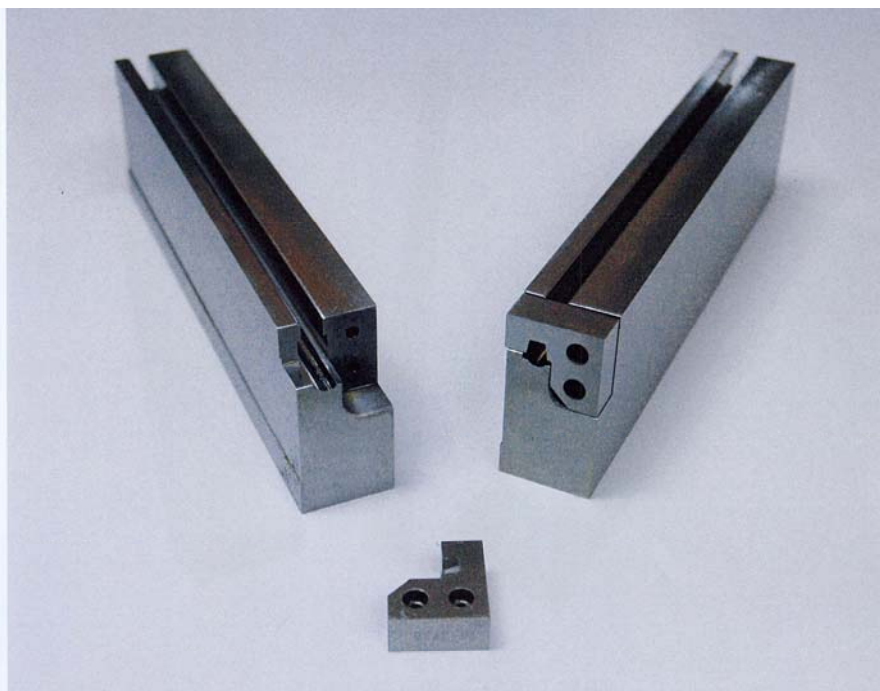

SPARE PARTS
INSULATING TOOL



1044



Bennett 
BARCELONA - SPAIN

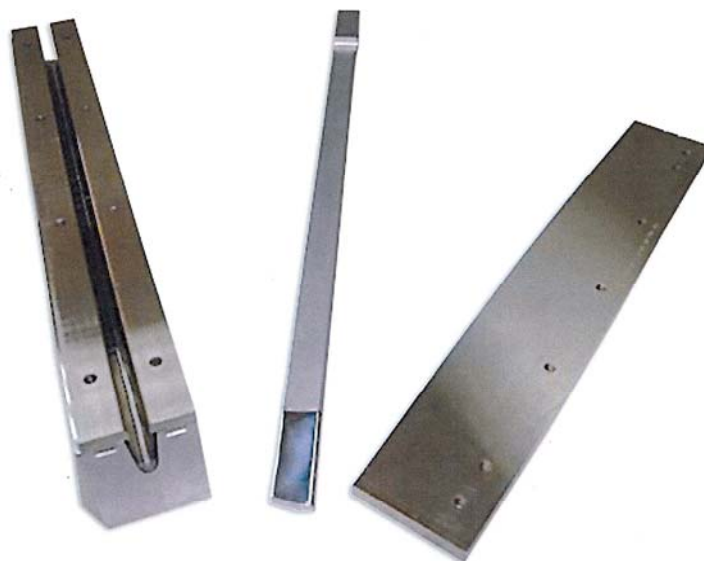

INSULATING TOOL - STATOMAT SE 320



1060



Bennett 
BARCELONA - SPAIN

MP TRADE, V Pláni 534/14, 142 00 Praha 4, Česká republika

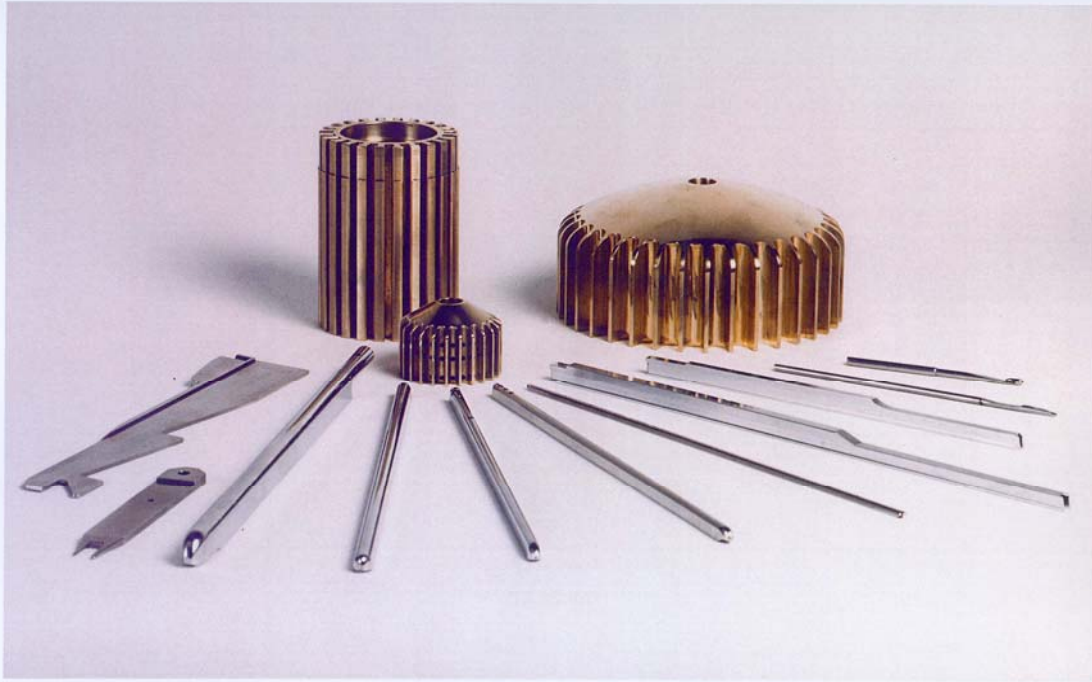

PIEZAS DE RECAMBIO - SPARE PARTS



1019



DIN EN ISO 9001:2000
Certificado N° 01 100 048108

Bennett *TBS*

BARCELONA - SPAIN

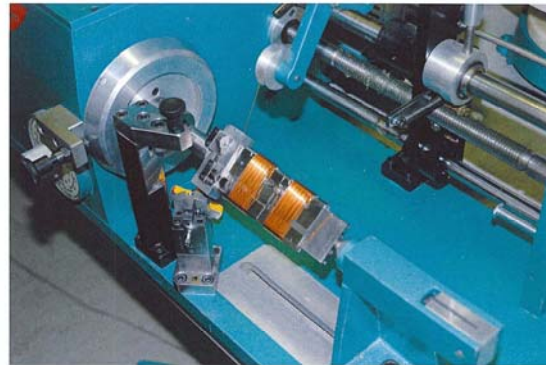
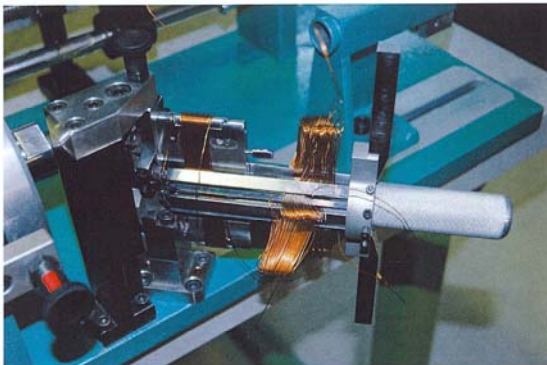

WINDING MACHINE
BENNETT BM-50



1048



DIN EN ISO 9001:2000
Certificado N° 01 100 048108

Bennett *TBS*

BARCELONA - SPAIN